

DLED-1565-DOB

120V-277V AC

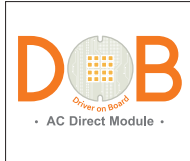

Catalog #		Type
Project		Date
Prepared by		

6" DOB LED Surface Cylinders with Wide Beam Reflector

6" LED Cylinder

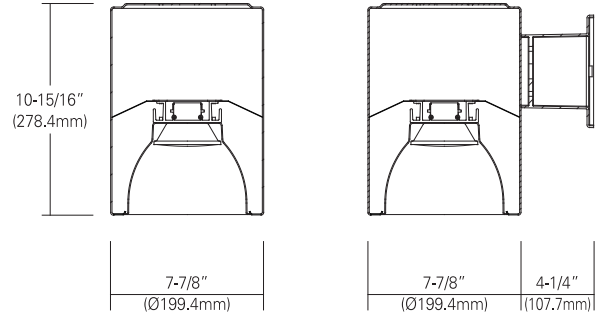

[Ceiling Mount : DLED-1565C-DOB] [Wall Mount : DLED-1565LC-DOB]

DESCRIPTION

6" aperture cylinder light with AC module by customized IC, embedded circuit on board for full dimming by most of Triac or 0-10V dimming switches in the market. Low heat, long life running from DOB technology can warrant more than 5years in weather change circumstances with (-30~+40) range.

SPECIFICATION

LED Quantity	1EA		
Input Voltage	120V-277V AC		
Wattage (Typ)	15 W	20 W	30 W
Lumen (Typ)	1,200	1,600	2,400
Efficacy (LPW)	80 lm/W	80 lm/W	80 lm/W
Beam Angle	52°		55°
C R I (Typical)	80, 90		
Color (+/-5%)	2700K, 3000K, 4000K, 5000K		
Dimming	Triac & 0-10V the both(Consult with factory for approved dimmers)		

FEATURES and FUNCTIONS

- Durable aluminum extrusion heat sink intergrated with DOB (driver on board).
- DOB modules with integrated circuit on board with customized chips (No driver needed)
- 80, 90 CRI, 2700K, 3000K, 4000K and 5000K
- Triac and 0-10V dimmable

Listing

- CSA-us Certificated
- State of California Title 24
- Energy star Approved & Listed
- Damp location

Warranty

- 5years of lamp life.

ORDERING INFORMATION

Housing	Pendant Stem Length	Watts	CRI	CCT	Housing Finish	Reflector Finish	Optional Baffle Finish
DLED-1565C-DOB Ceiling Mount	12 12 Inches	15 15W	8 80	27 2700K	WH White	HC Haze Clear	WH White
DLED-1565LC-DOB Wall Mount	18 18 Inches	20 20W	9 90	30 3000K	BK Black	WH White	BK Black
DLED-1565PC-DOB Pendant Mount	24 24 Inches	30 30W		40 4000K	BZ Bronze		
	36 36 Inches						
	48 48 Inches						
	*For Pendant Mount Only						*Consult with factory for custom finishes

Example : DLED-1565PC-DOB-12-15-840-WH-HC

- - - - -